

300kg/段 高さ1800×横幅1550×奥行870×3段(枚) 単体 1台

備考:YSシリーズ:支柱×4本 単体自立型 ホワイトグレー

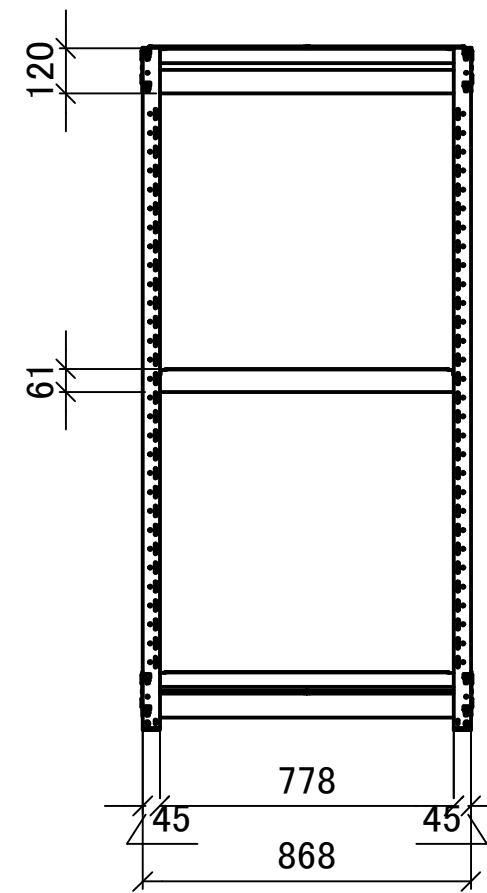
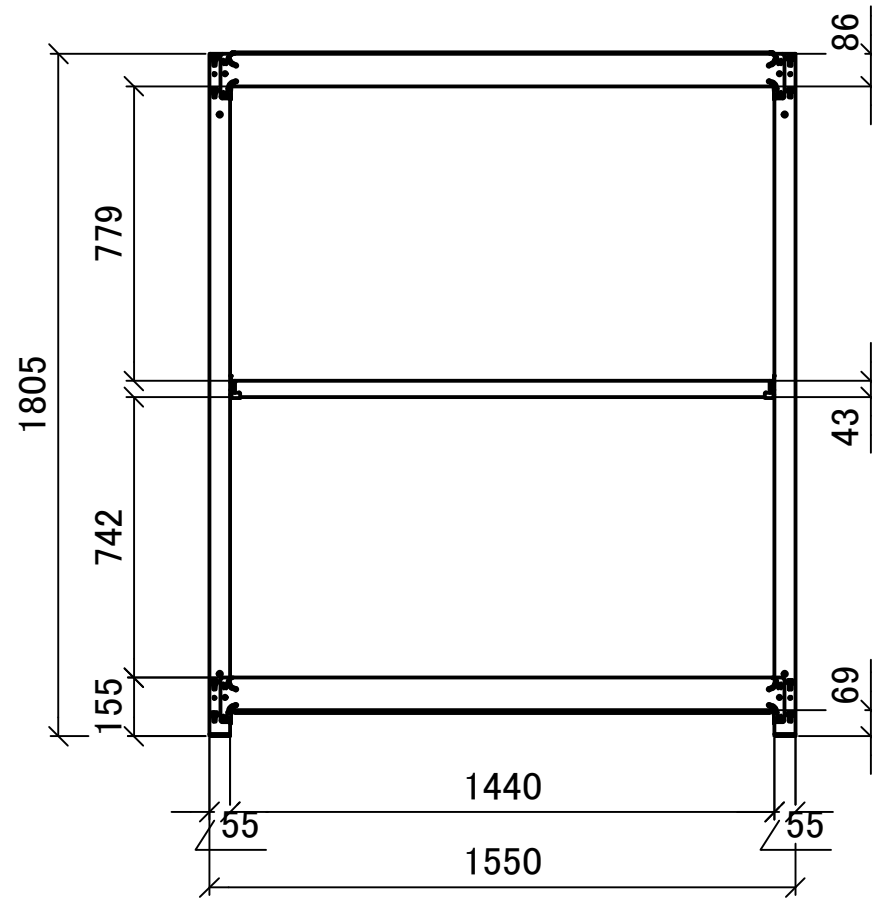
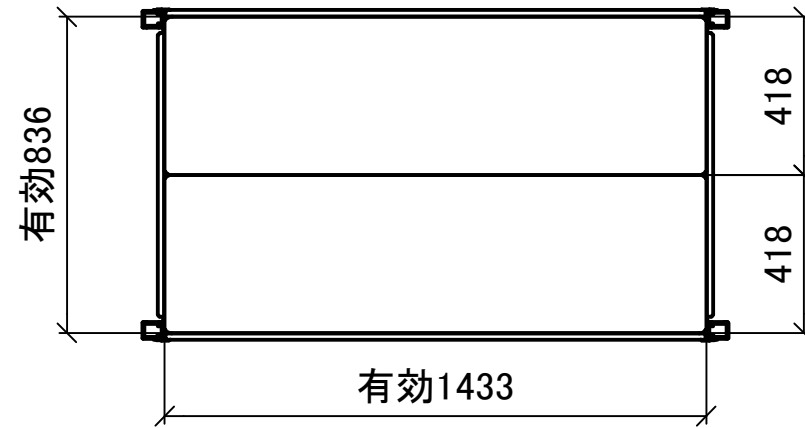
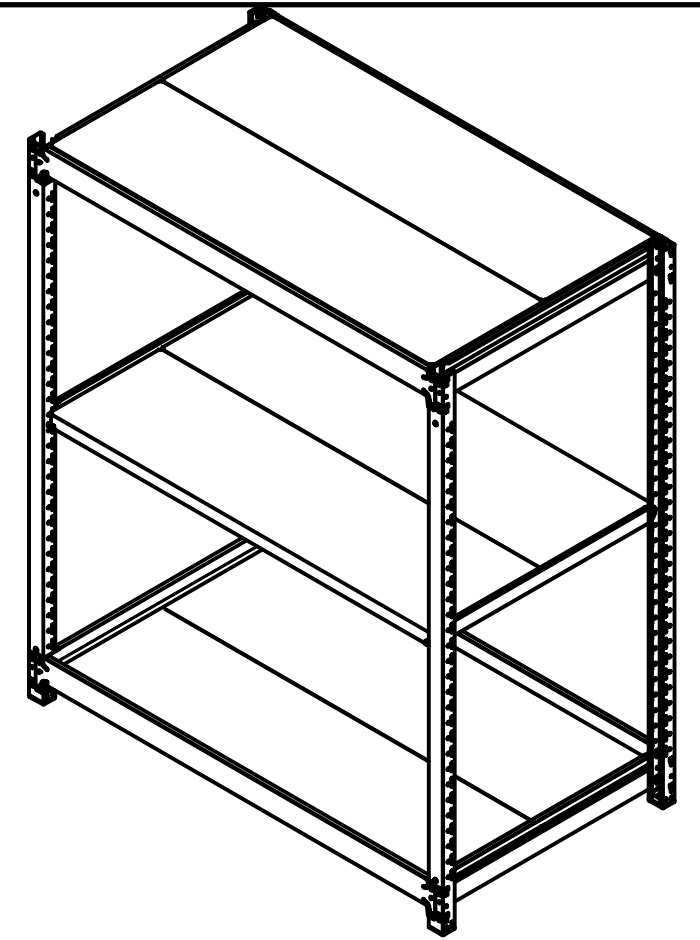

DATE 2025-07-08

DRAWN

CHECKED

PROJECT

TITLE スチールラック 中量YS 三面図

PROJECT NO.

USER

SCALE 1:20

SHEET NO. 1:1