

300kg/段 高さ1200×横幅1850×奥行870×2段(枚) 単体 1台

備考:YSシリーズ:支柱×4本 単体自立型 ホワイトグレー

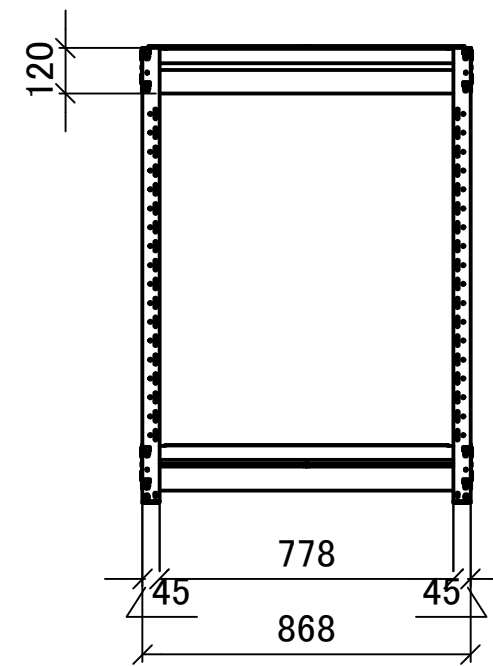
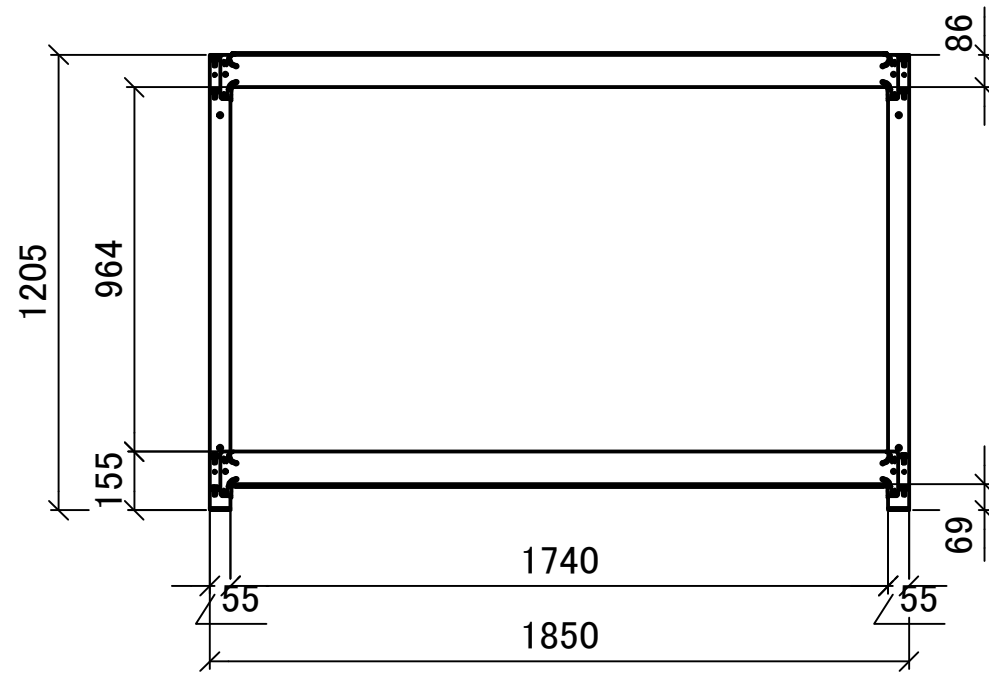
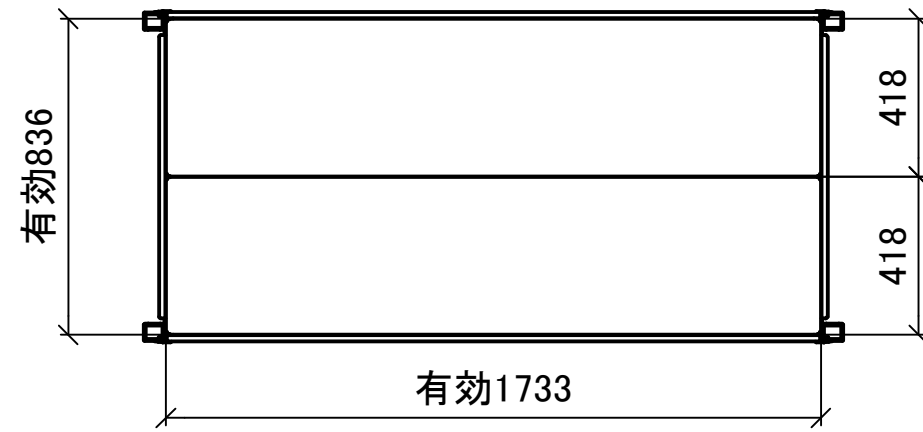
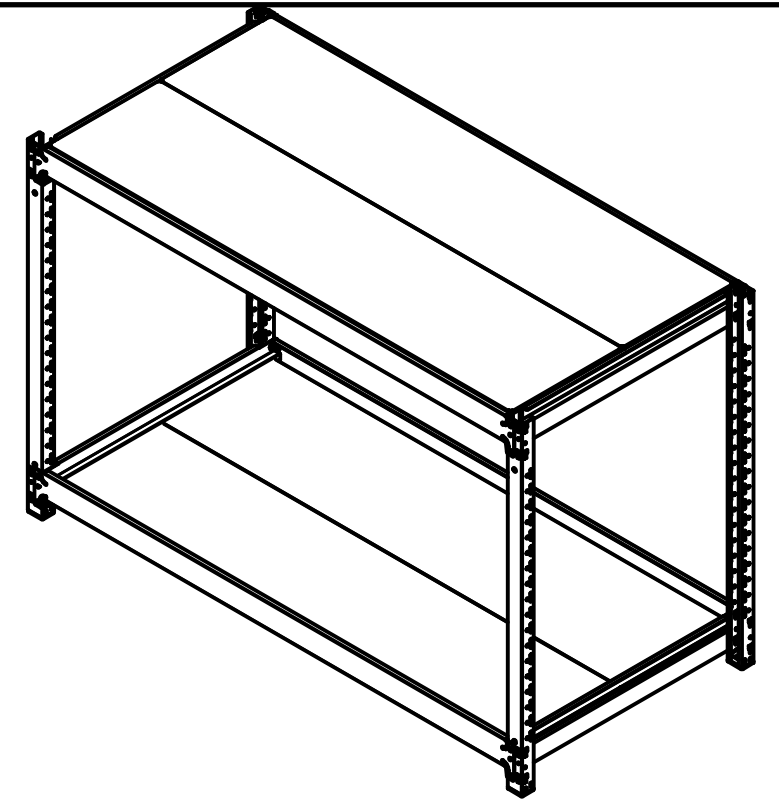

DATE 2025-07-04  
DRAWN  
CHECKED

PROJECT  
TITLE スチールラック 中量YS 三面図

PROJECT NO.  
USER

SCALE 1:20  
SHEET NO. 1:1