

150kg/段 高さ1500×横幅1800×奥行600×7段(枚) 単体 1台

備考:SOシリーズ:支柱×4本 単体自立型 ホワイトグレー

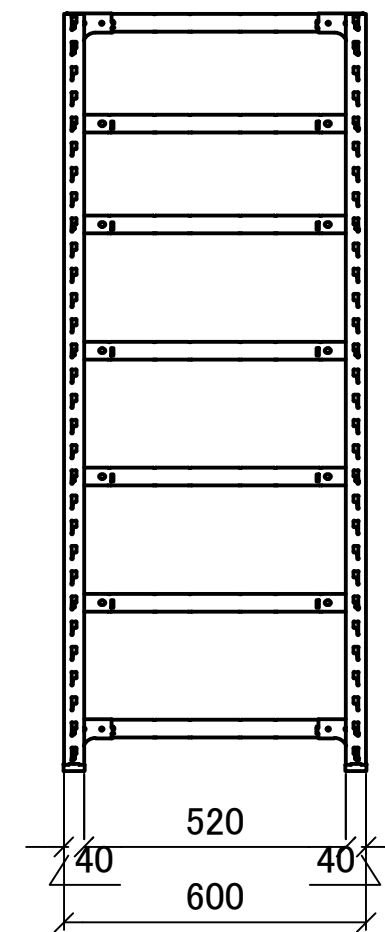
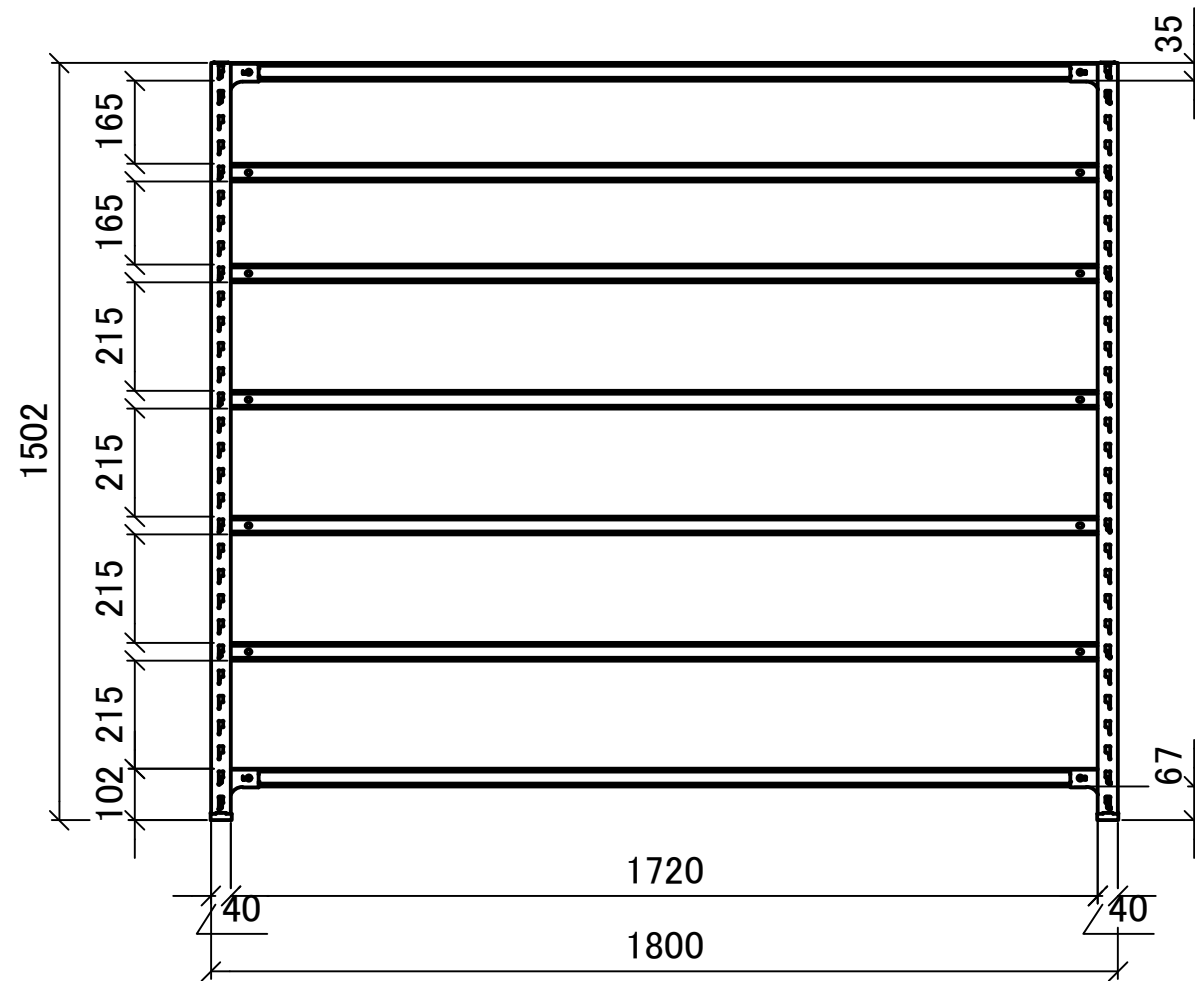
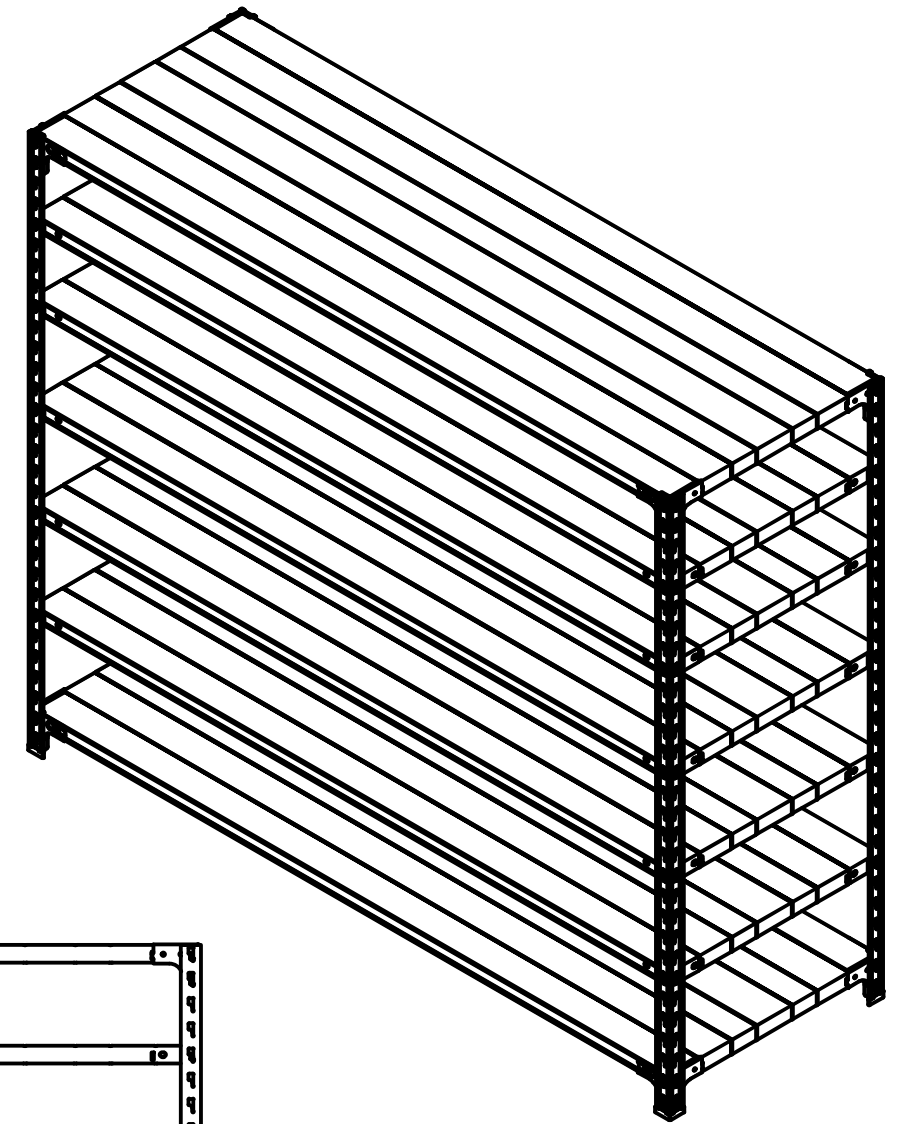

DATE 2025-07-01
DRAWN
CHECKED

PROJECT
TITLE スチールラック 軽量SO 三面図

PROJECT NO.
USER

SCALE 1:15
SHEET NO. 1:1